























KEY LEGEND

-  DUPLEX RECEPTACLE
-  DUPLEX RECEPTACLE TOP HALF SWITCHED
-  GF DUPLEX RECEPTACLE GROUND FAULT
-  FLOOR DUPLEX RECEPTACLE
-  R RANGE RECEPTACLE
-  M MICROWAVE RECEPTACLE
-  W WASHER RECEPTACLE
-  D DRYER RECEPTACLE
-  * DUPLEX RECEPTACLE ABOVE COUNTER
-  J JUNCTION BOX
-  TD TELEPHONE-DATA OUTLET
-  TV TELEVISION-DATA OUTLET
-  T1 TELEPHONE OUTLET
-  DB DOOR BELL-INTERIOR
-  DB DOOR BELL
-  RECESSED LOW VOLTAGE PANEL
-  RECESSED ELECTRICAL PANEL
-  S WALL SWITCH
-  S₃ THREE-WAY SWITCH
-  S_{3D} THREE-WAY DIMMER SWITCH
-  CPT. CARPET
-  LVT. LUXURY VINYL TILE

FINLEY III - UNIT 450 FLOOR PLAN

SCALE: 3/16"=1'-0"



SEARSTONE
RETIREMENT COMMUNITY

APPROVED:
DATE:

FINLEY III

*FLOOR PLAN
SUBJECT TO CHANGE

SHEET 1 OF 4

9'-5" CEILING HEIGHT UNLESS NOTED OTHERWISE

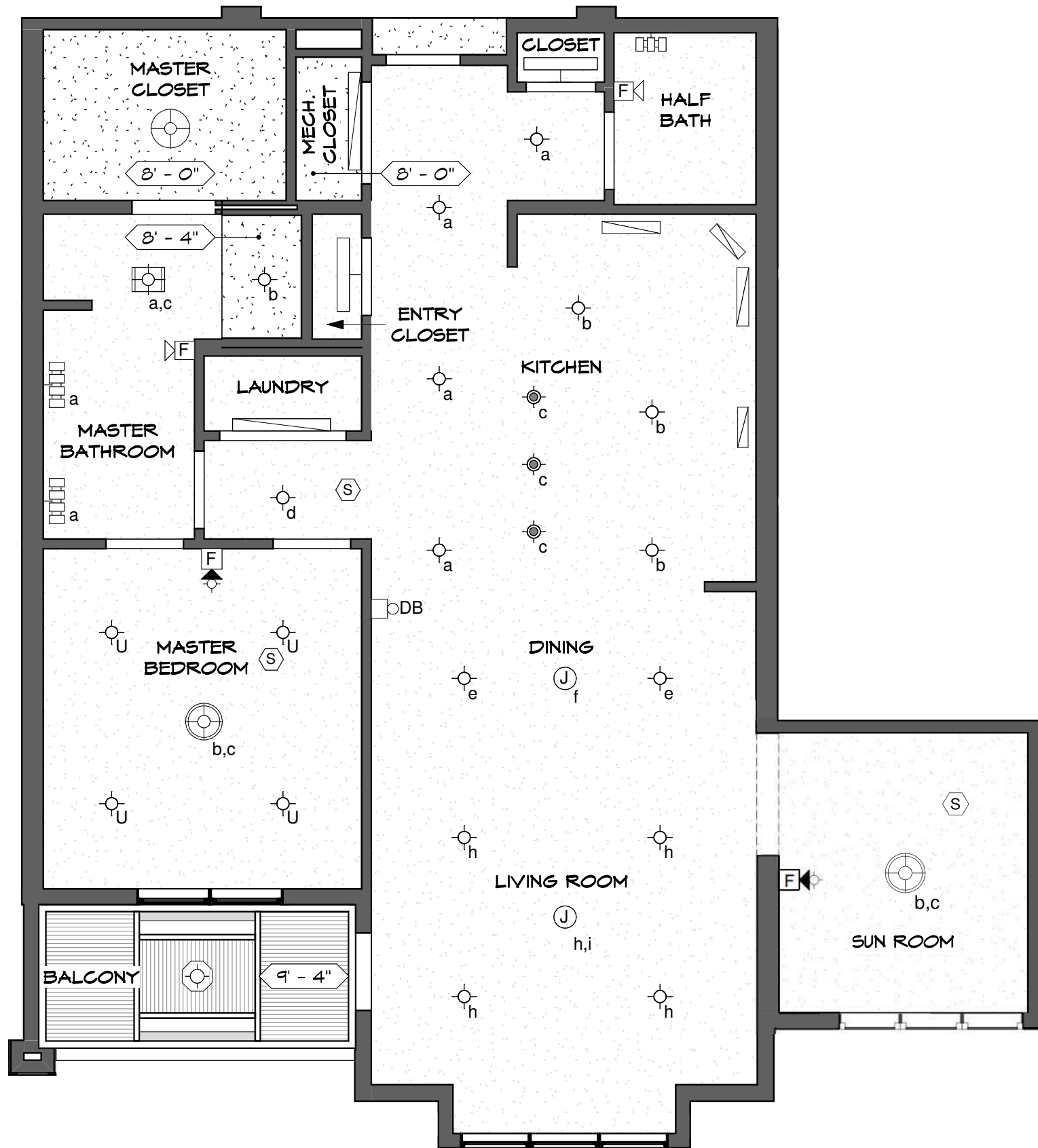

KEY LEGEND

- JUNCTION BOX
- SMOKE DETECTOR
- 4" DIAM. SHOWER LIGHT FIXTURE
- 6" DIAM. SURFACE MOUNTED LIGHT FIXTURE
- 6.5" DIAM. PENDANT LIGHT FIXTURE
- 18" DIAM. PENDANT LIGHT FIXTURE
- 19" DIAM. PENDANT LIGHT FIXTURE
- COMBINATION LIGHT/HEATER/FAN
- COMBINATION LIGHT/FAN
- VANITY LIGHT BAR (3)
- VANITY LIGHT BAR (4)
- UNDERCABINET LIGHT FIXTURE
- 36" TROFFER LIGHT FIXTURE
- 48" TROFFER LIGHT FIXTURE
- BALCONY LIGHT FIXTURE
- UPGRADE - 6" DIAM. SURFACE MOUNTED LIGHT FIXTURE
- FIRE ALARM AUDIO/VISUAL DEVICES
- FIRE ALARM AUDIO DEVICE

FINLEY III - UNIT 450 REFLECTED CEILING PLAN

SCALE: 3/16"=1'-0"



SEARSTONE
RETIREMENT COMMUNITY

APPROVED:	FINLEY III
DATE:	
*FLOOR PLAN SUBJECT TO CHANGE	SHEET 2 OF 4

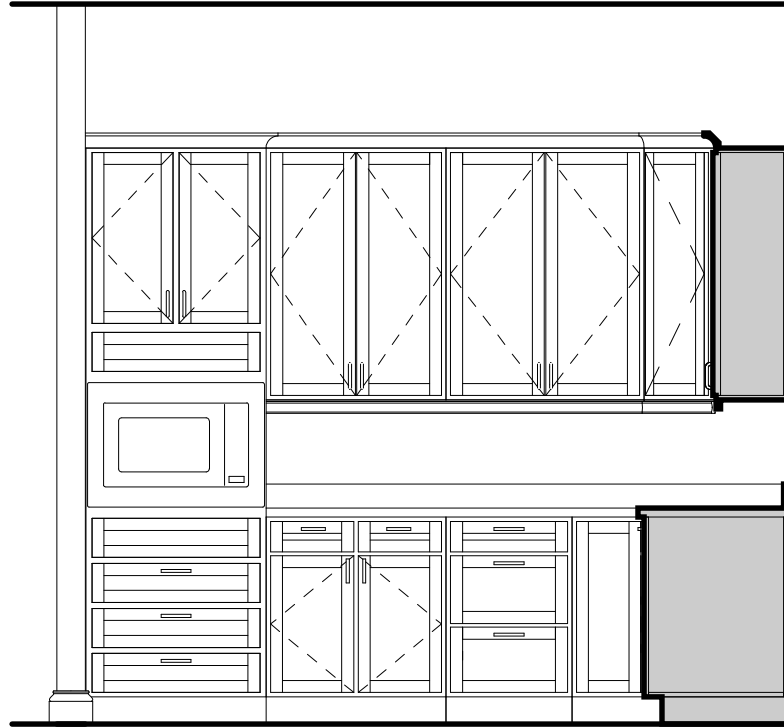

1 - KITCHEN ELEVATION

SCALE: 3/8" = 1'-0"

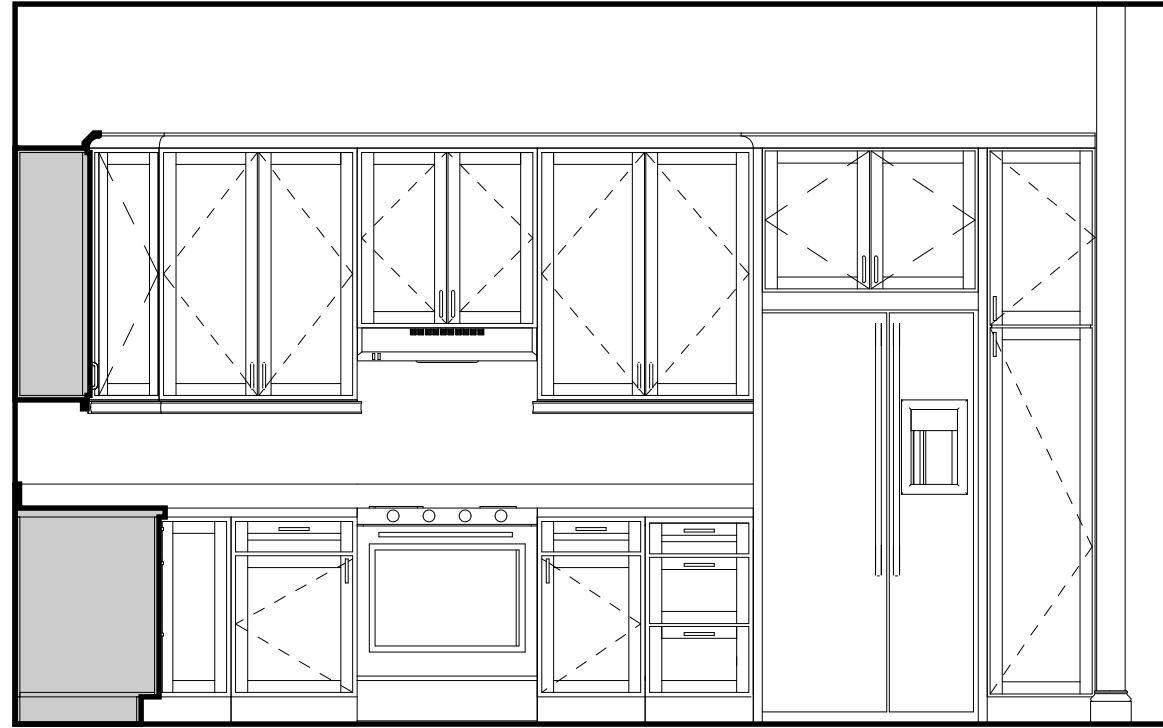

2 - KITCHEN ELEVATION

SCALE: 3/8" = 1'-0"

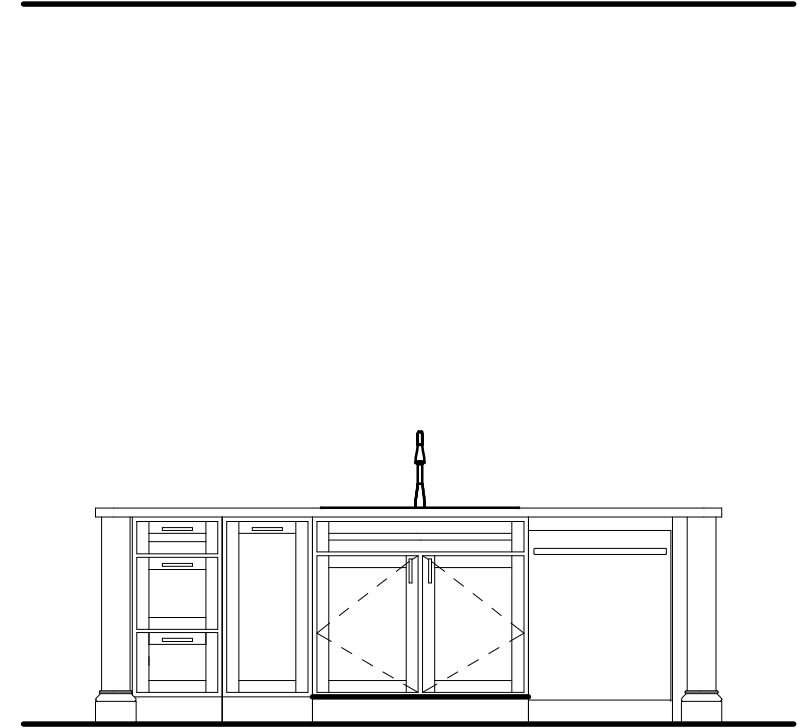

3 - KITCHEN ELEVATION

SCALE: 3/8" = 1'-0"

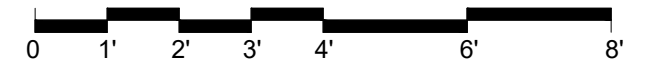

 SEARSTONE RETIREMENT COMMUNITY	
APPROVED: DATE:	FINLEY III
*FLOOR PLAN SUBJECT TO CHANGE	SHEET 3 OF 4

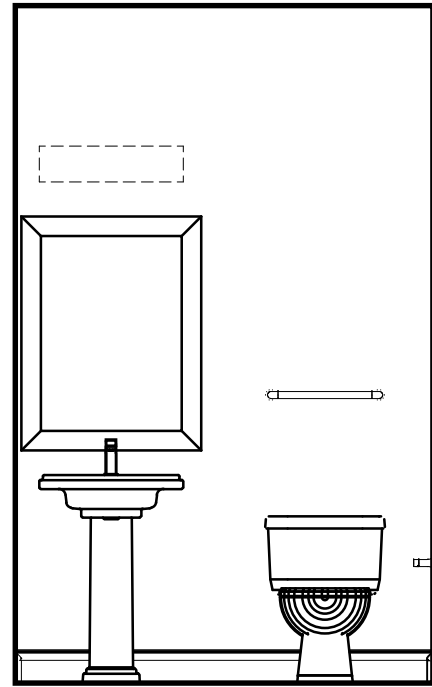

4 - BATHROOM ELEVATION

SCALE: 3/8" = 1'-0"

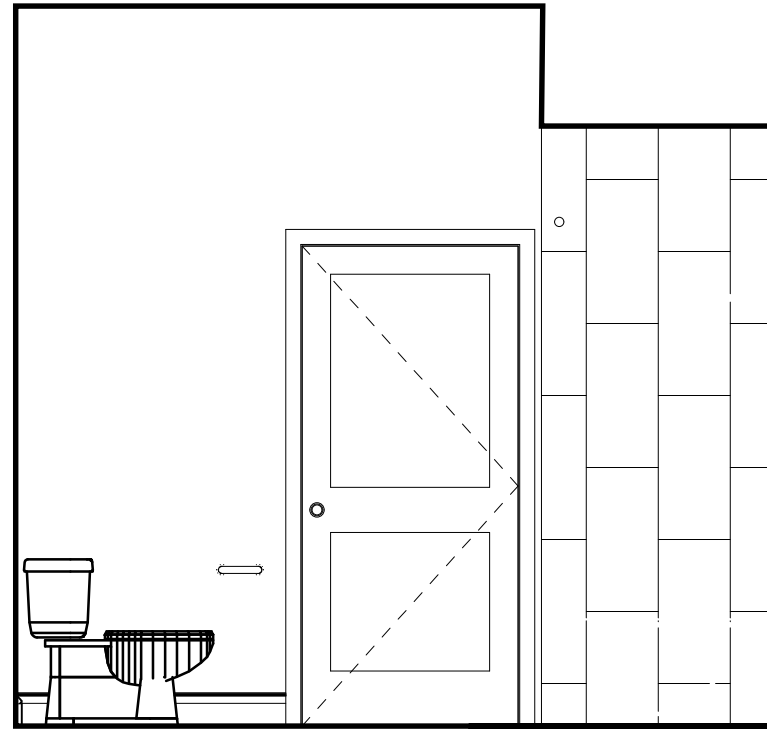

5 - BATHROOM ELEVATION

SCALE: 3/8" = 1'-0"

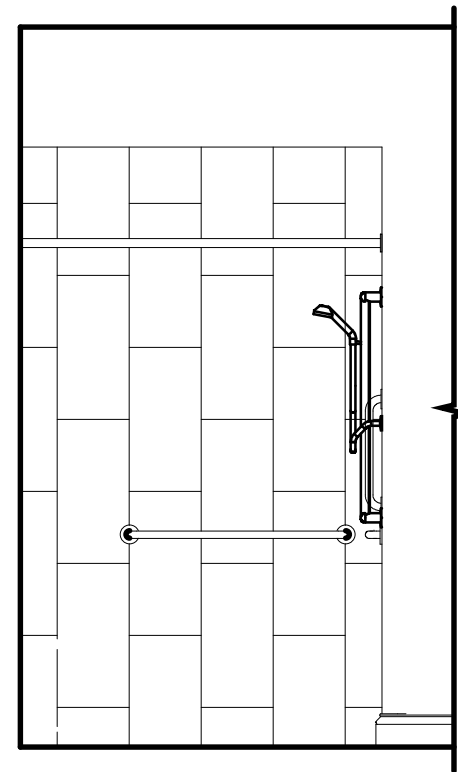

6 - BATHROOM ELEVATION

SCALE: 3/8" = 1'-0"

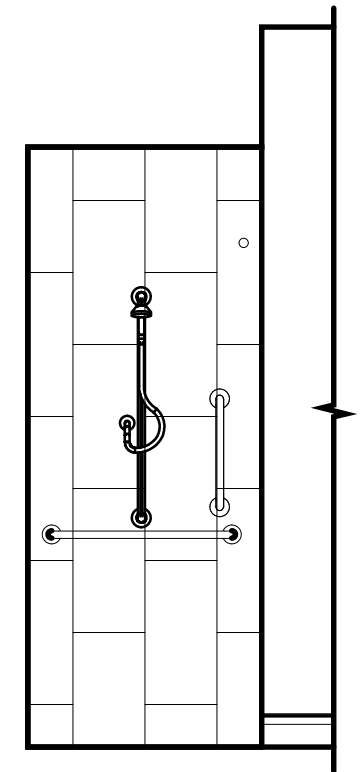

7 - BATHROOM ELEVATION

SCALE: 3/8" = 1'-0"

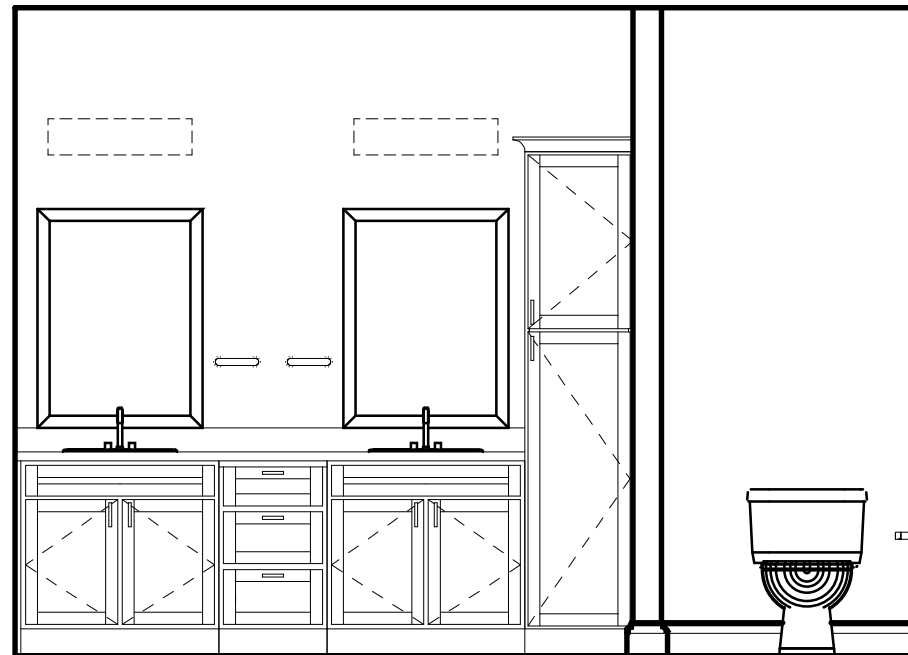

8 - BATHROOM ELEVATION

SCALE: 3/8" = 1'-0"

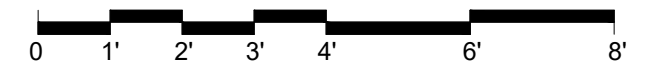

 SEARSTONE RETIREMENT COMMUNITY	
APPROVED: DATE:	FINLEY III
*FLOOR PLAN SUBJECT TO CHANGE	SHEET 4 OF 4