

**KEY LEGEND**

- DUPLEX RECEPTACLE
- DUPLEX RECEPTACLE TOP HALF SWITCHED
- GF DUPLEX RECEPTACLE GROUND FAULT
- FLOOR DUPLEX RECEPTACLE
- R RANGE RECEPTACLE
- M MICROWAVE RECEPTACLE
- W WASHER RECEPTACLE
- D DRYER RECEPTACLE
- \* DUPLEX RECEPTACLE ABOVE COUNTER
- J JUNCTION BOX
- TD TELEPHONE-DATA OUTLET
- TV TELEVISION-DATA OUTLET
- T1 TELEPHONE OUTLET
- DB DOOR BELL-INTERIOR
- DB DOOR BELL
- RECESSED LOW VOLTAGE PANEL
- RECESSED ELECTRICAL PANEL
- S WALL SWITCH
- S<sub>3</sub> THREE-WAY SWITCH
- S<sub>3D</sub> THREE-WAY DIMMER SWITCH
- CPT. CARPET
- LVT. LUXURY VINYL TILE

**SIMONE II - UNIT 442 FLOOR PLAN**

SCALE: 3/16"=1'-0"



**SEARSTONE**  
RETIREMENT COMMUNITY

APPROVED:  
DATE:

SIMONE II

\*FLOOR PLAN  
SUBJECT TO CHANGE

SHEET 1 OF 4



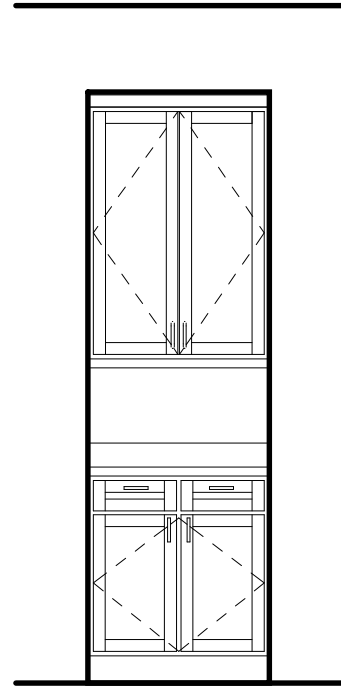

1 - KITCHEN ELEVATION

SCALE: 3/8" = 1'-0"

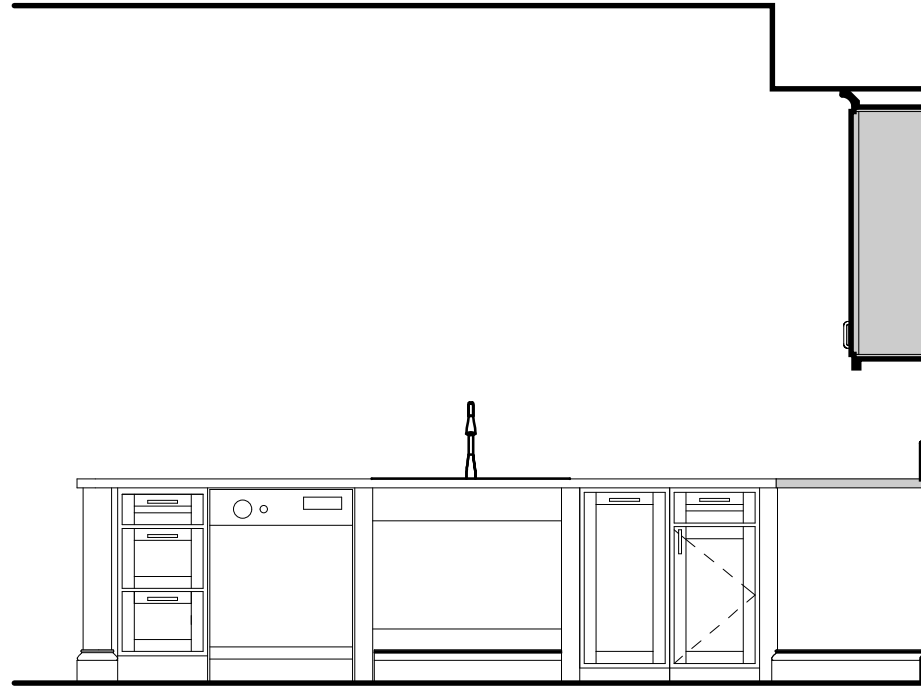

2 - KITCHEN ELEVATION

SCALE: 3/8" = 1'-0"

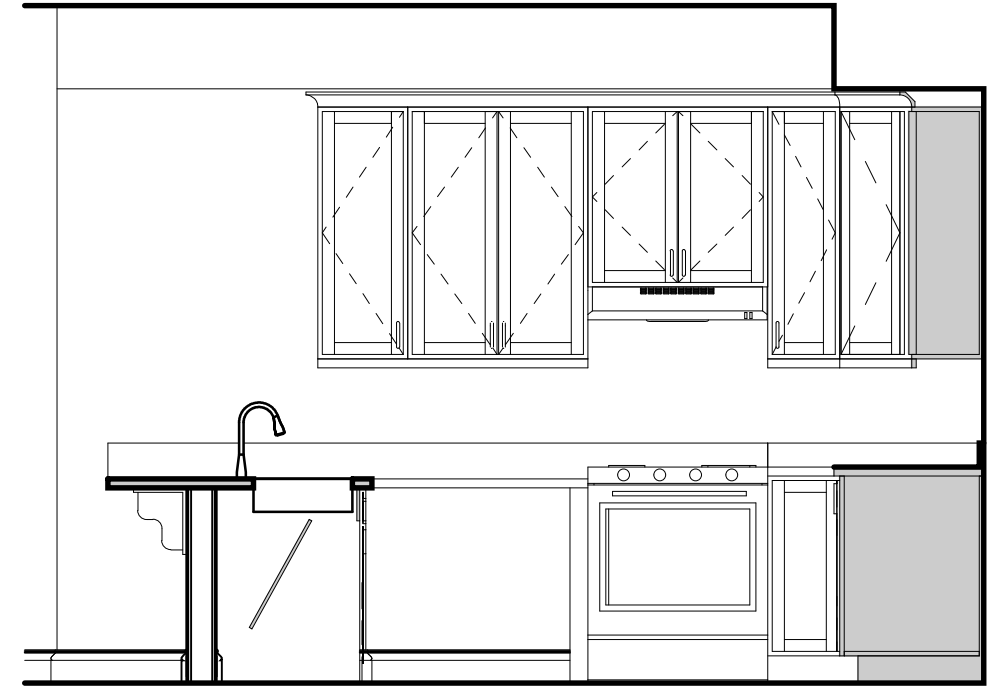

3 - KITCHEN ELEVATION

SCALE: 3/8" = 1'-0"

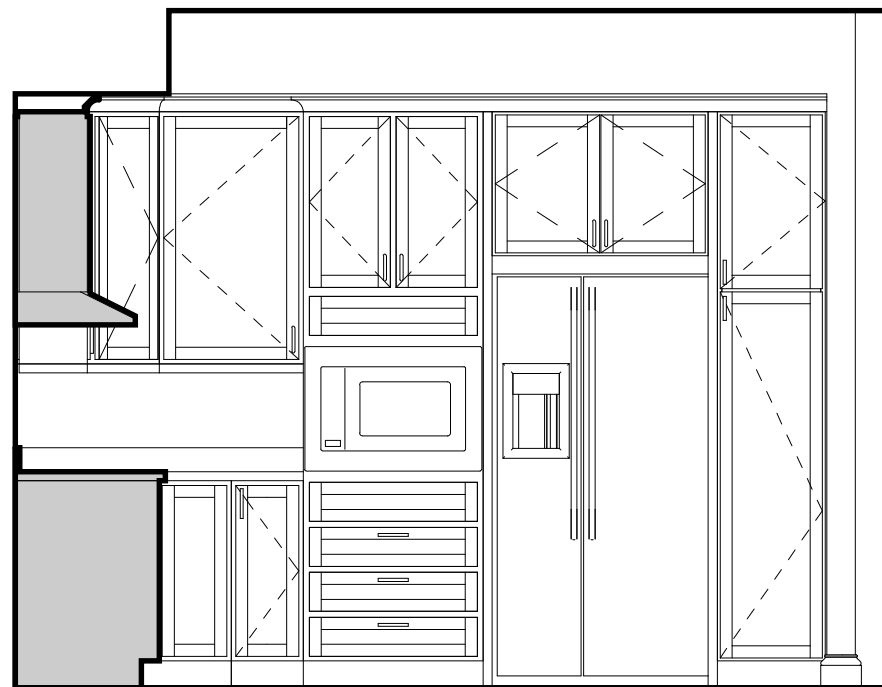

4 - KITCHEN ELEVATION

SCALE: 3/8" = 1'-0"

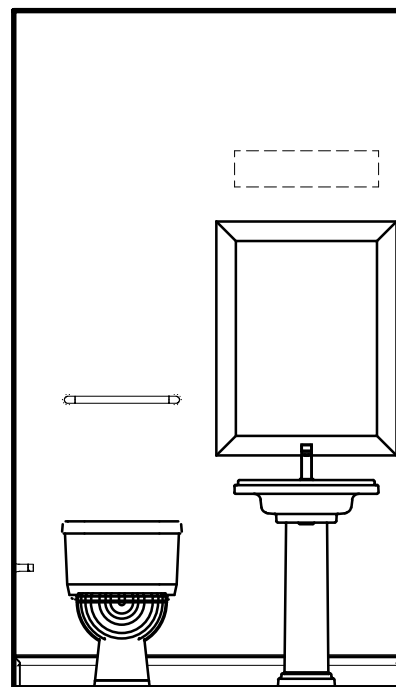

5 - BATHROOM ELEVATION

SCALE: 3/8" = 1'-0"

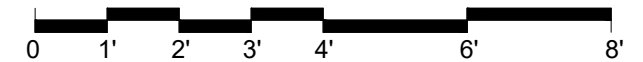

 <b>SEARSTONE</b> RETIREMENT COMMUNITY	
APPROVED: DATE:	SIMONE II
*FLOOR PLAN SUBJECT TO CHANGE	SHEET 3 OF 4

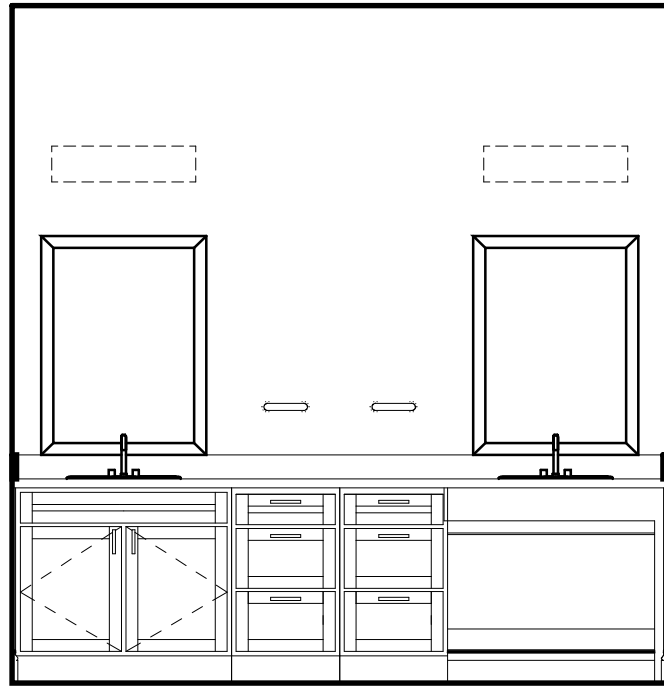

6 - BATHROOM ELEVATION

SCALE: 3/8" = 1'-0"

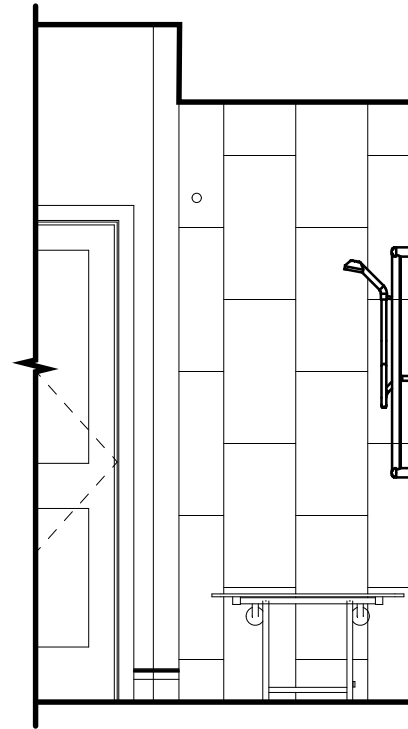

7 - BATHROOM ELEVATION

SCALE: 3/8" = 1'-0"

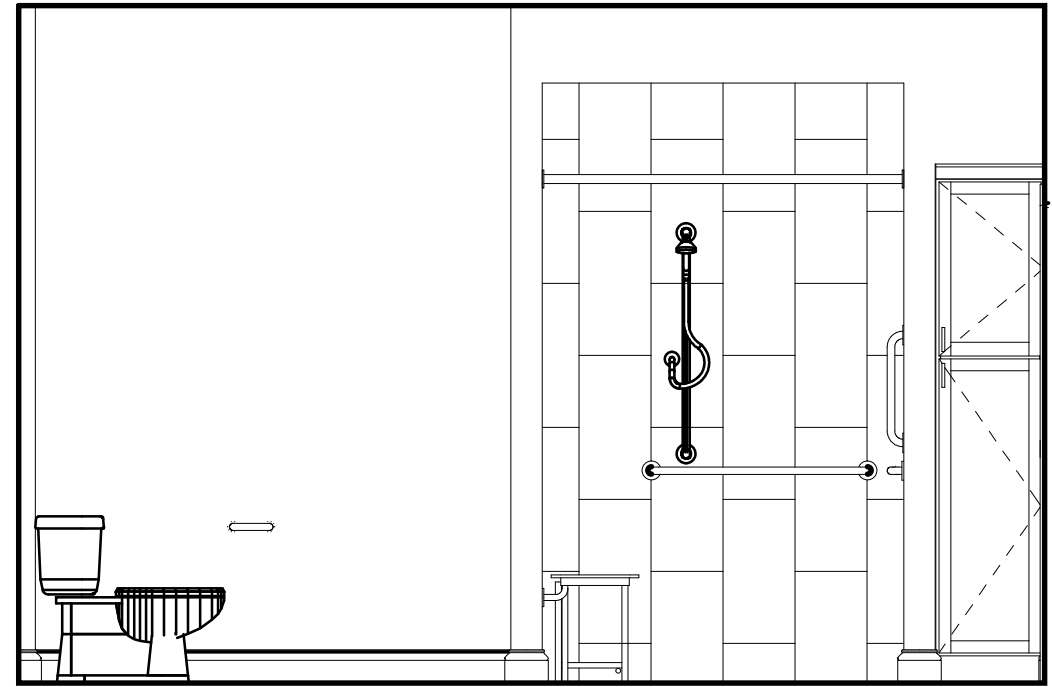

8 - BATHROOM ELEVATION

SCALE: 3/8" = 1'-0"

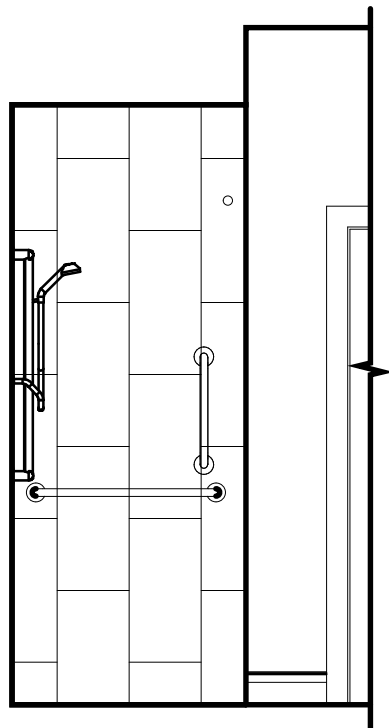

9 - BATHROOM ELEVATION

SCALE: 3/8" = 1'-0"

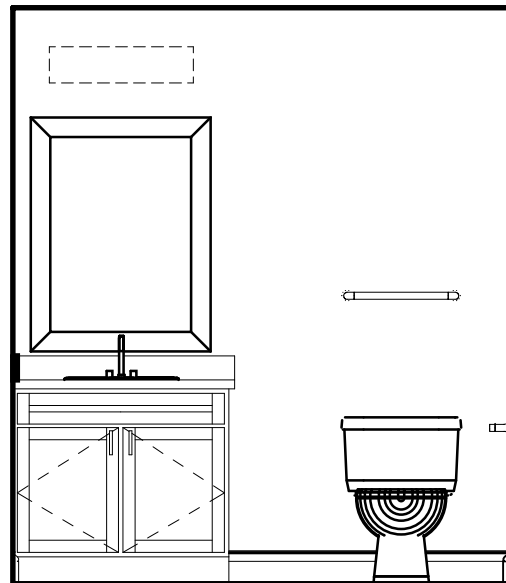

10 - BATHROOM ELEVATION

SCALE: 3/8" = 1'-0"

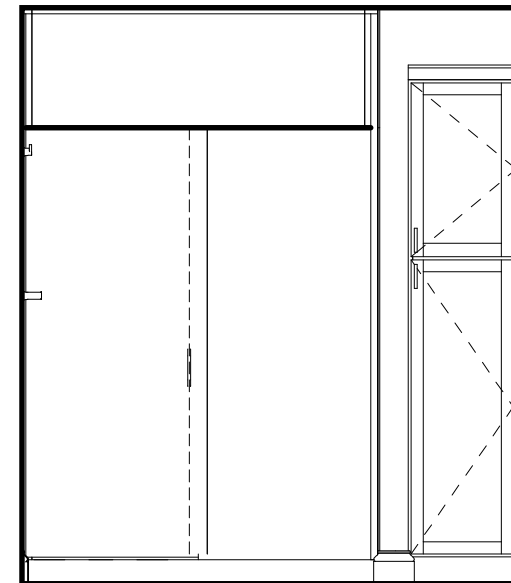

11 - BATHROOM ELEVATION

SCALE: 3/8" = 1'-0"

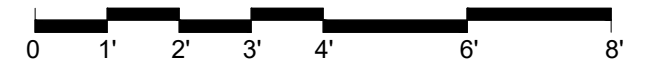

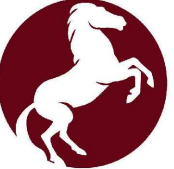
 <b>SEARSTONE</b> RETIREMENT COMMUNITY	
APPROVED: DATE:	SIMONE II
*FLOOR PLAN SUBJECT TO CHANGE	SHEET 4 OF 4